



We create chemistry

MABMEM – a material toolbox for the modification of ultrafiltration membranes

Oliver Gronwald

BASF SE

Advanced Materials & Systems RAP/OUB

Aachen, 15.11.2018

Outline

- Introduction (filtration technologies, membrane materials)
- Objectives MABMEM project
- Results MABMEM project (properties of FS and SB ultrafiltration membranes)
- Results on testing of dizzer modules
- Conclusion

Introduction

Overview on filtration technologies

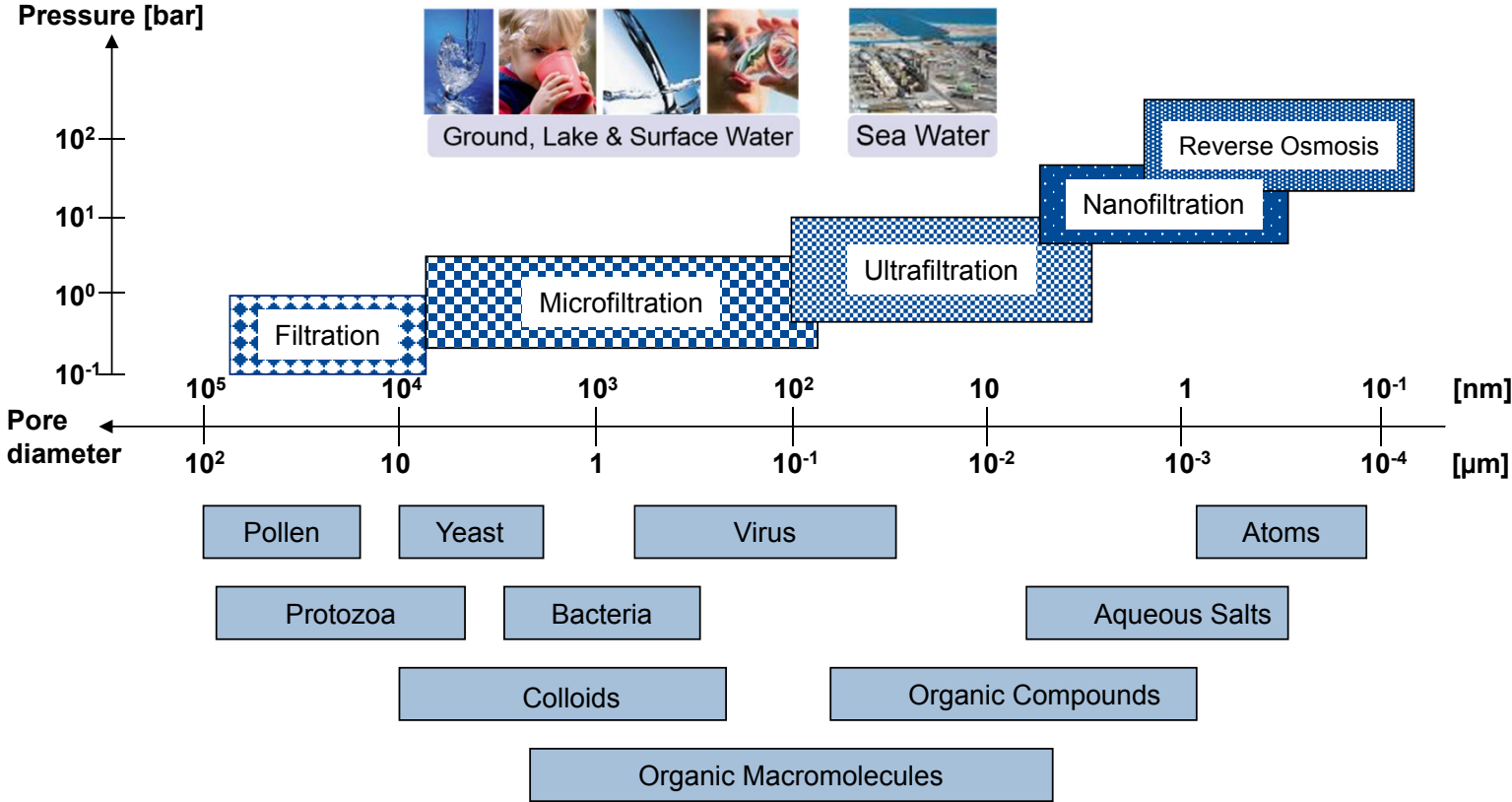

MABMEM project: Objectives

New membrane materials

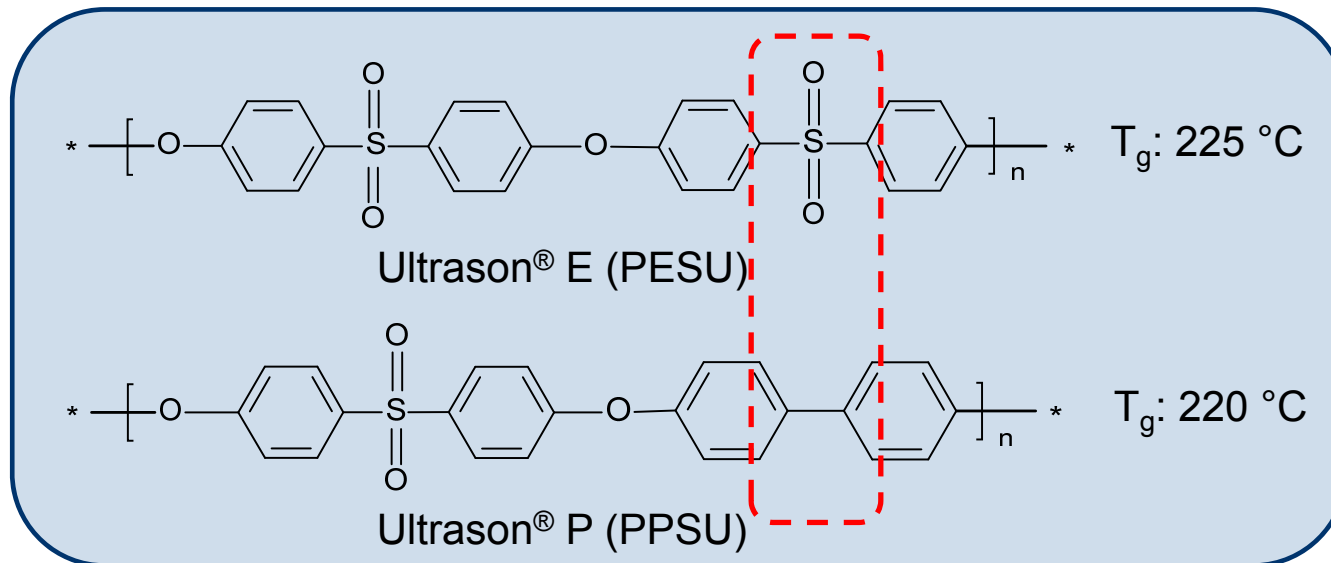

- ~ 30 % of ultrafiltration membranes are based on PESU
- PPSU: Tight UF-membranes: lower permeability and cut-off compared to PESU
- But, compared to PESU, PPSU has improved stability against oxidation
- Currently, no PPSU membranes commercially available



<https://machwas-material.de>

GEFÖRDERT VOM



03XP0043A



MABMEM project: partners and project structure

New membrane materials

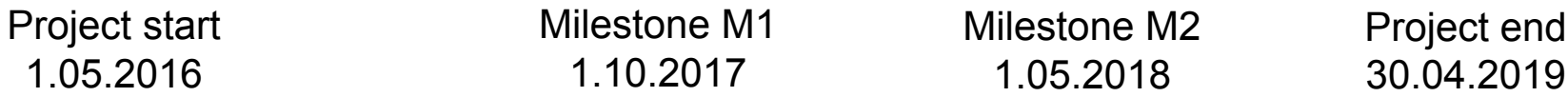

- Additive synthesis
- Testing in flat sheet membranes
- Optimization (structure, recipe)
- Hollow fiber membrane spinning
- Assembly to laboratory modules
- Module testing

- Multibore fiber spinning
- Demonstrator assembly

- Demonstrator testing
 - surface water
 - waste water



<https://machwas-material.de>

GEFÖRDERT VOM



03XP0043A

- Funding measure "Materials for a sustainable water management - MachWas"
- Sponsored by German Federal Ministry of Education and Research (BMBWF)



Results MABMEM project: additive synthesis

New membrane materials – UF membranes based on PPSU

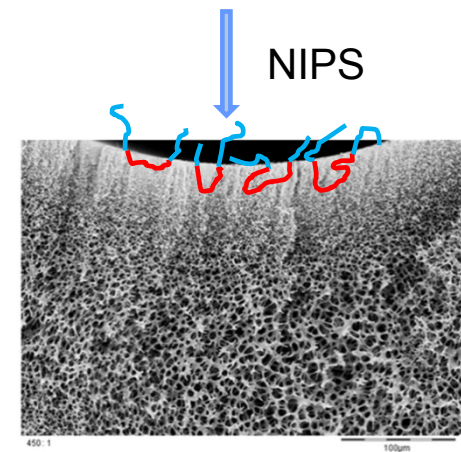
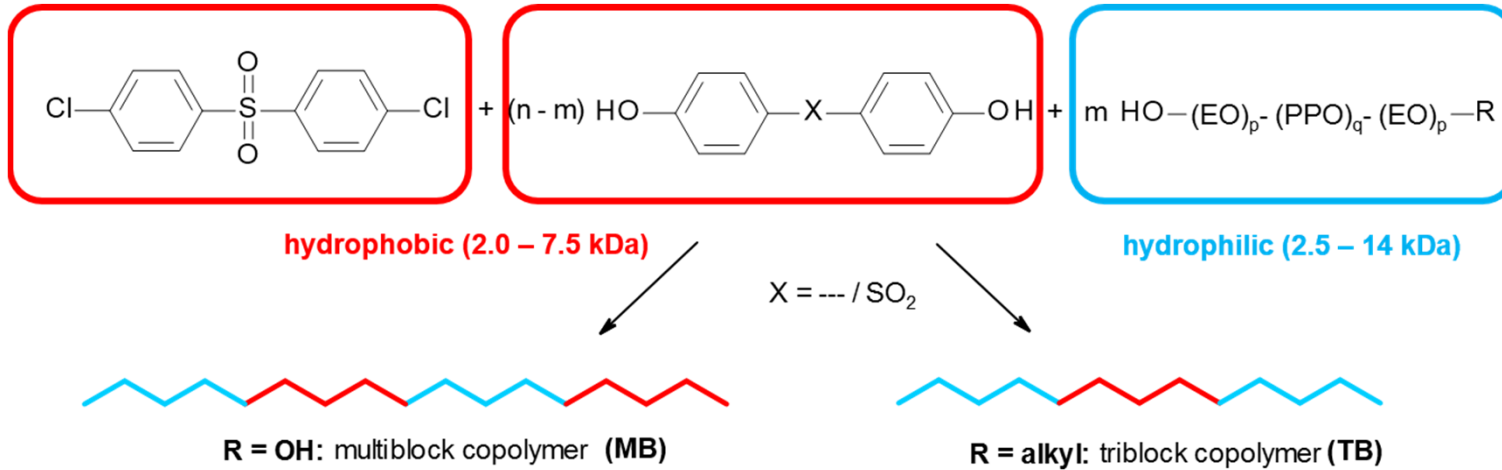

structure	type	molecular weight (M _n)	PEO share	polyethersulfone X = -SO ₂ - (PESU)			polyphenylsulfone X = --- (PPSU)		
				2.0 k	5.0 k	7.5 k	2.0 k	5.0 k	7.5 k
H(O-CH ₂ -CH ₂)-OAlkyl	Lutensol® AT80	~ 3500 g/mol	97 %	✓	✓	✓	✓	✓	✓
	Lutensol® AT50	~ 2500 g/mol	92 %	✓					
	Pluriol® A 5010 E	~ 5000 g/mol	99 %	✓	✓				
H(O-CH ₂ -CH ₂)-OH	Pluriol® E 8000	~ 8000 g/mol	100 %	✓		✓			✓
H[EO]-[PO]-[EO]-OH	Pluronic® F127	~ 14000 g/mol	73 %	✓		✓	✓		✓

Results MABMEM project – membrane properties

PPSU FS membranes with MABMEM additives: PWP, MWCO

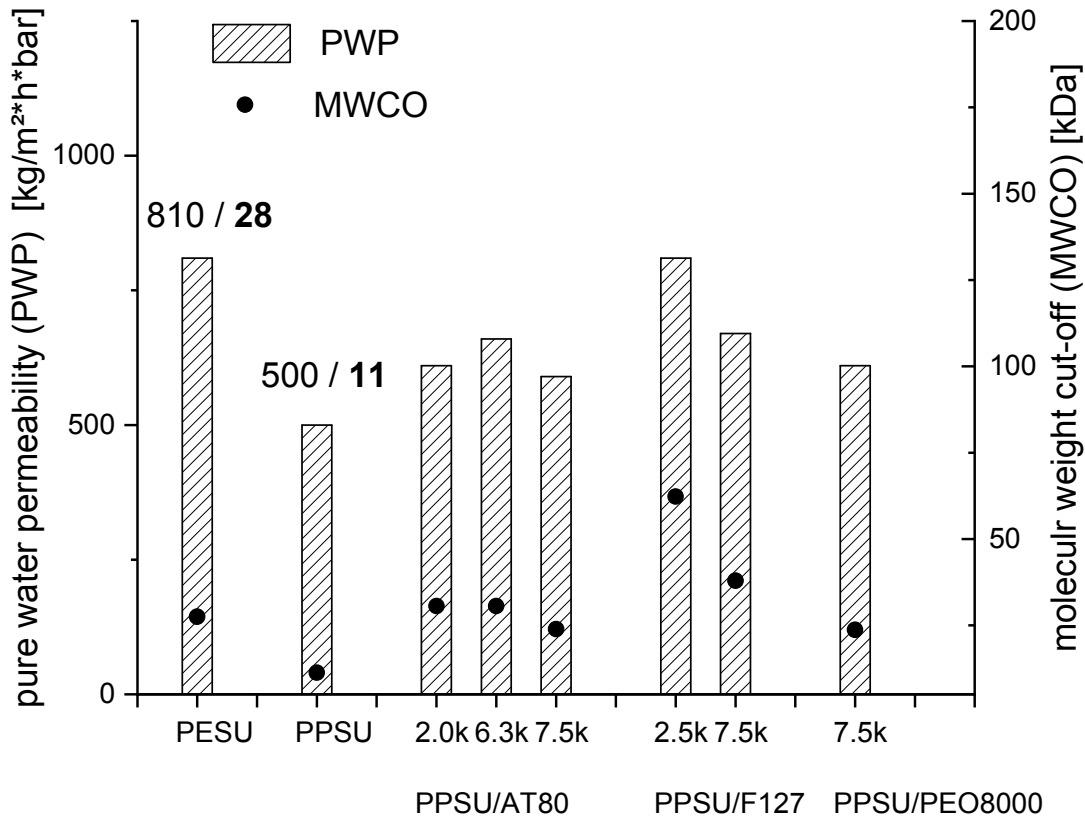

PPSU UF membranes with MABMEM additives

- 8.4 wt% additive relative to PPSU matrix polymer
- 18 – 62 % permeability increase compared PPSU ultrafiltration membranes
- Highest permeability of 810 $\text{kg/m}^2\cdot\text{h}\cdot\text{bar}$ matches permeability of PESU standard membrane
- Molecular weight cut-off values with 23 – 62 kDa in ultrafiltration range

Results MABMEM project – membrane properties

PPSU FS membranes with MABMEM additives: morphology SEM

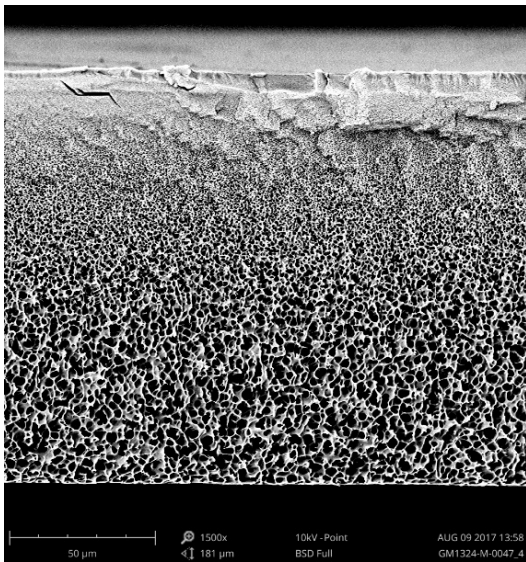

TB: 6.3 kDa PPSU/AT-80

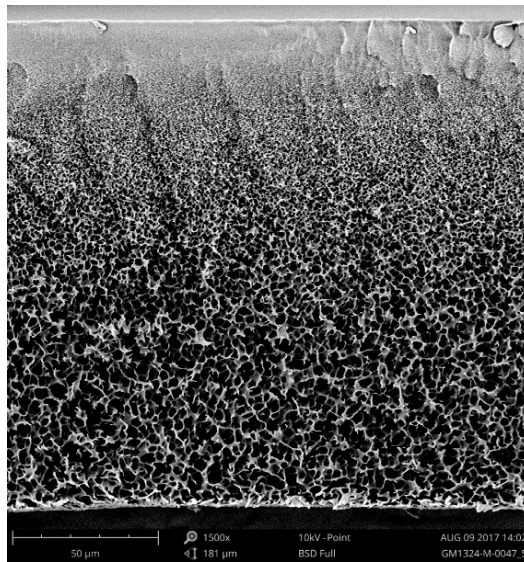

TB: 7.4 kDa PPSU/AT-80

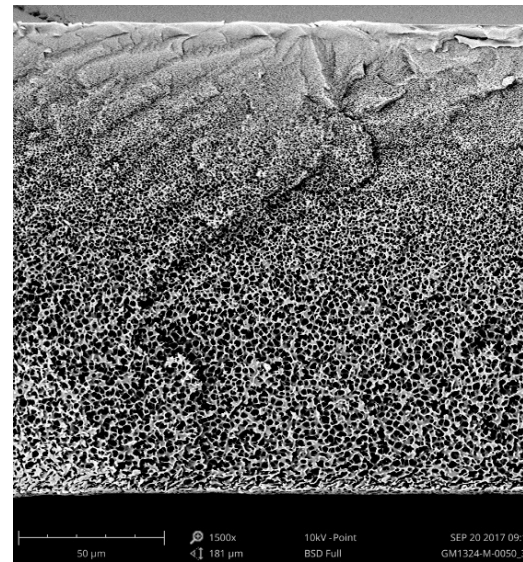

MB: 2.5 kDa PPSU/F 127

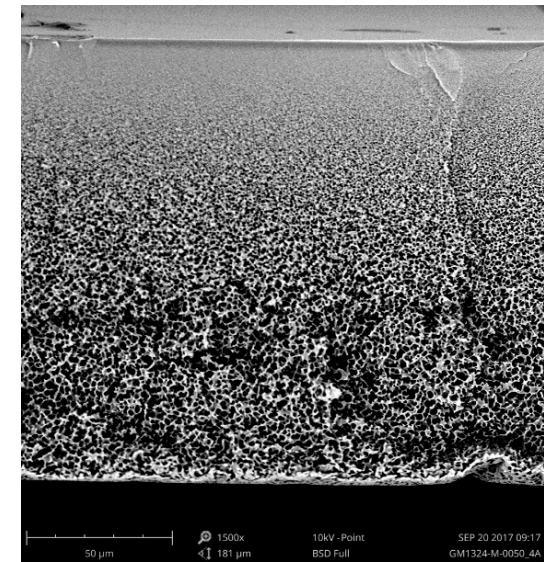

MB: 7.5 kDa PPSU/F 127

- Nano porous filtration layer, sponge type micro porous support layer
- No defects like macro voids

Results MABMEM project – membrane properties

PPSU FS membranes with MABMEM additives: water contact angle

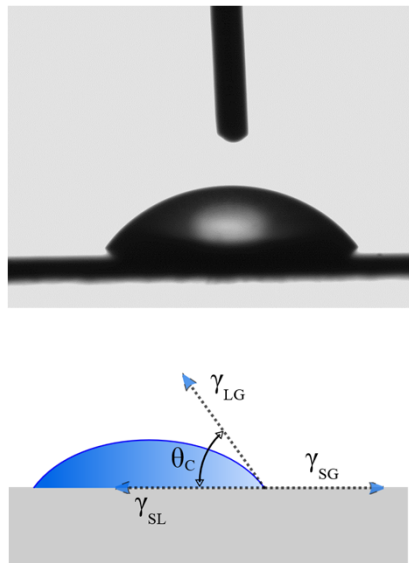

sessile drop mode

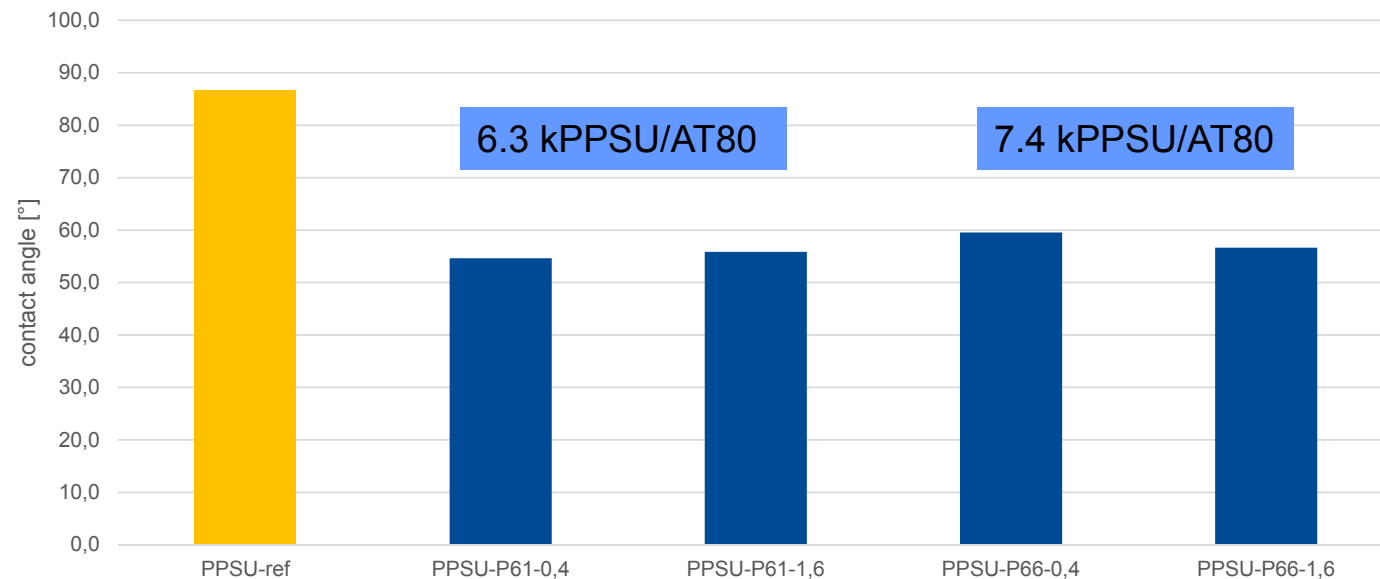

- PESU membranes: 70 – 75 °
- PPSU based additives in PPSU flat sheet membrane separation layer
- Presence of MABMEM additives lowers contact angle of separation layer

Results MABMEM project – membrane properties

PPSU SB membranes with MABMEM additives: surface enrichment

PPSU based additives in PPSU single bore (SB) membrane separation layer

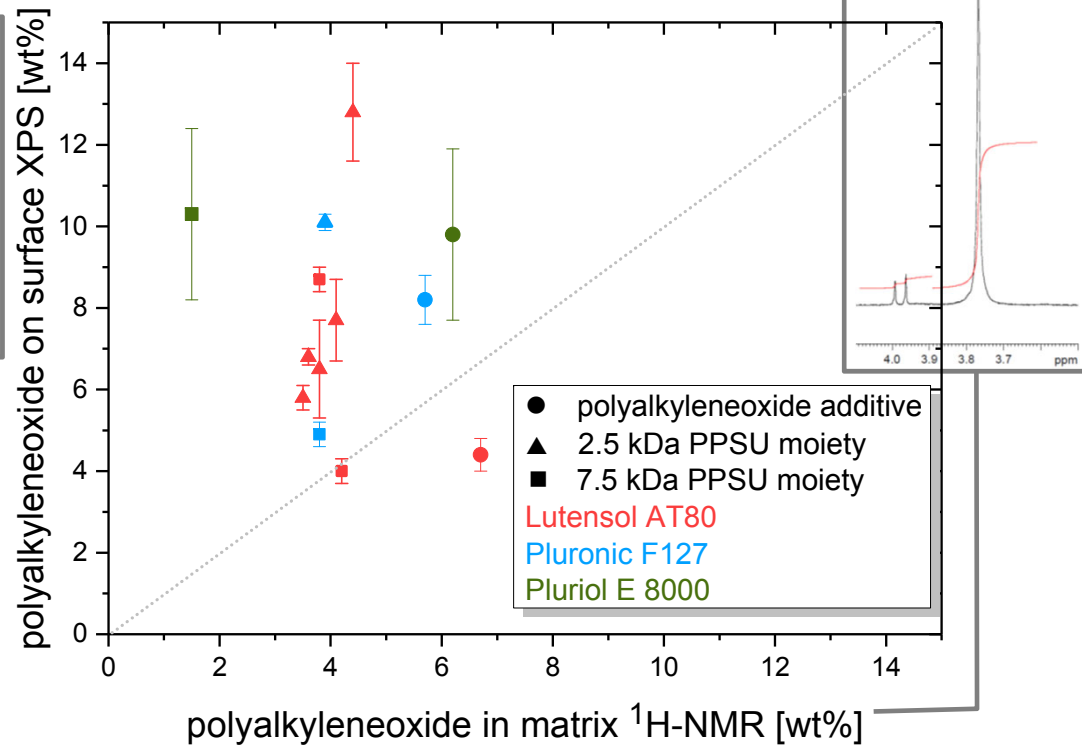
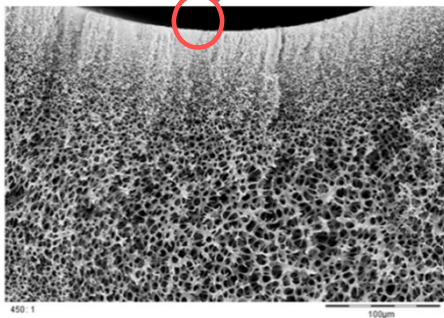
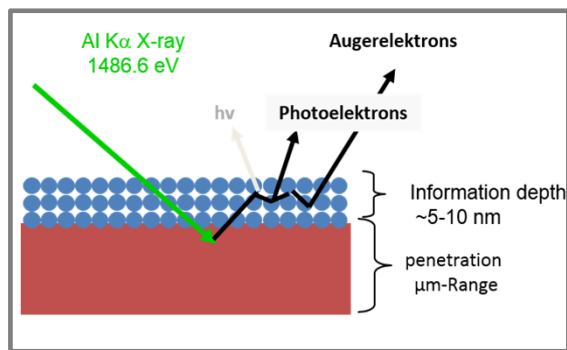

Results MABMEM project – membrane surface properties

PPSU SB membranes with MABMEM additives: fouling propensity

Fouling with diluted flower soil (3.5 mg/l dry mass) with 100 l/h – PPSU SB with TB 6.3kPPSU/AT80

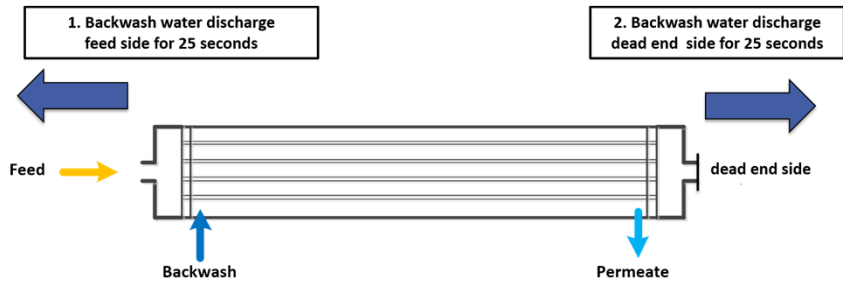
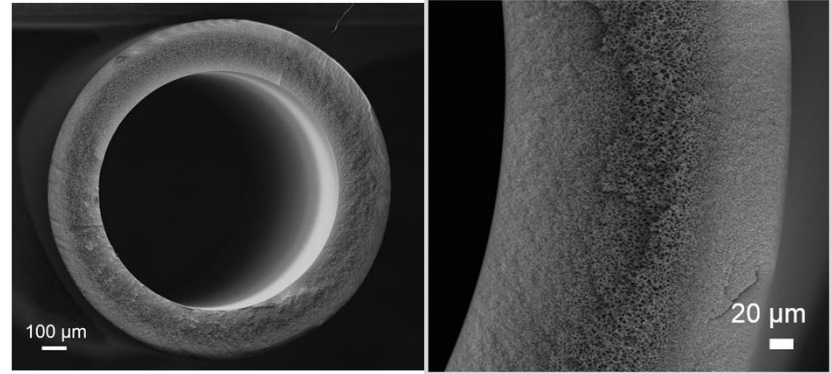
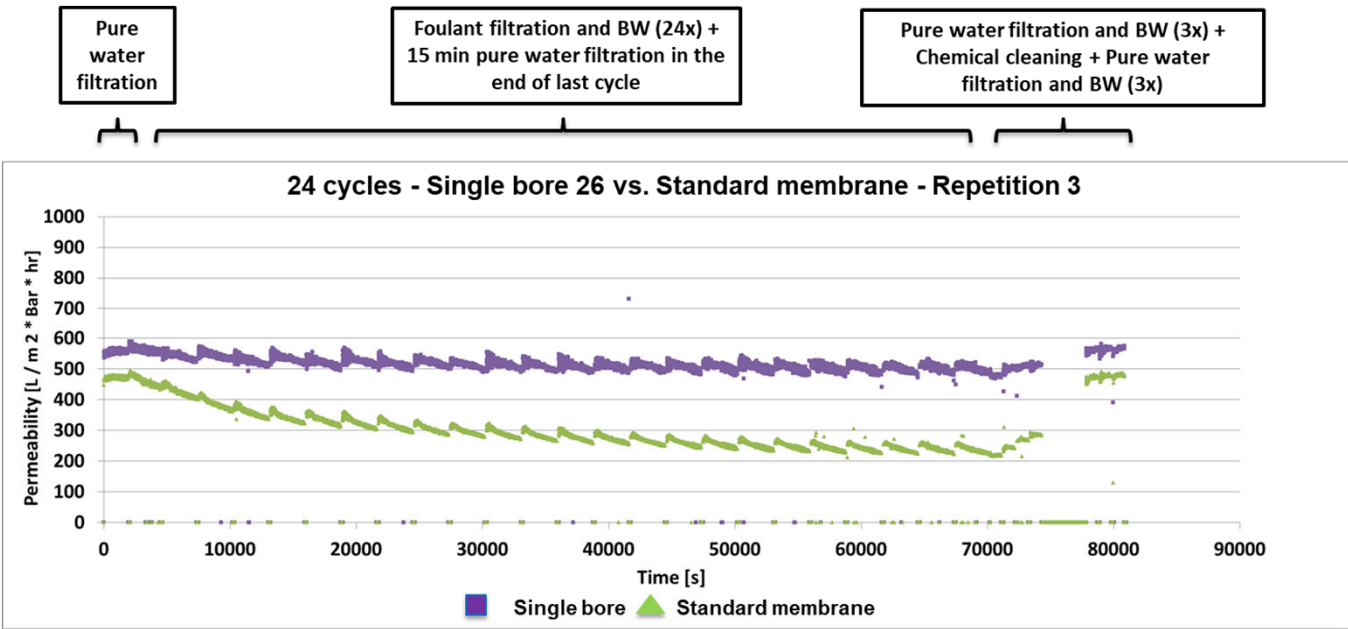

Significant reduced fouling propensity of modified PPSU membrane

Results MABMEM project – membrane surface properties

Upscaling of PPSU development candidates

PWP

MWCO

Fouling

SB	matrix	additive
26	PPSU	TB: 6.3k PPSU/AT80
27	PPSU	TB: 7.4k PPSU/AT80
30	PPSU	MB: 2.5k PPSU/F127
31	PPSU	MB: 7.5k PPSU/F127



Dizzer Lab modules
LAB 0.9 MB 0.2 Y

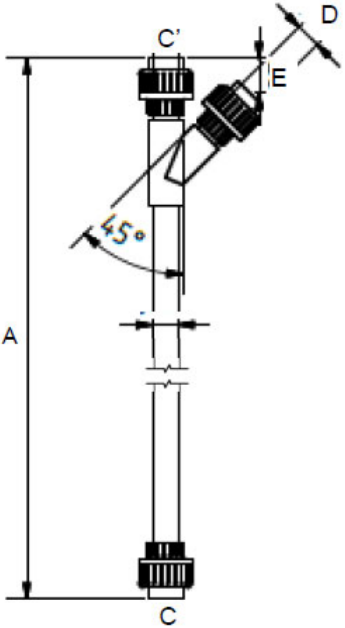

Length: 1558 mm
Area : 0.2 m²

Results MABMEM project – membrane surface properties

Upscaling of PPSU development candidates

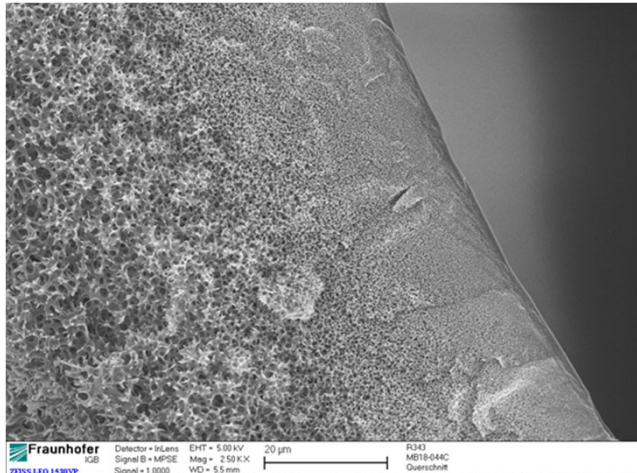
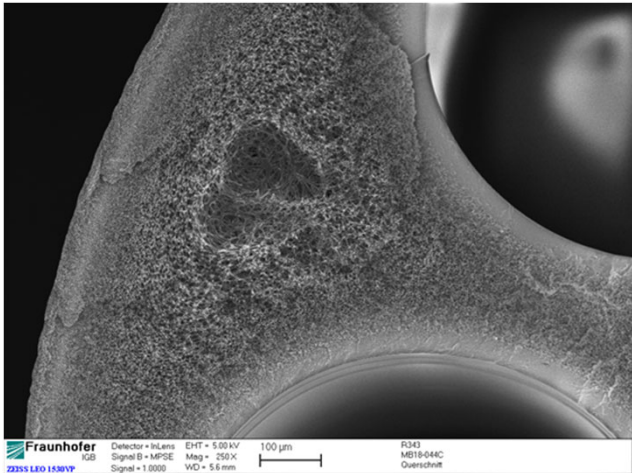
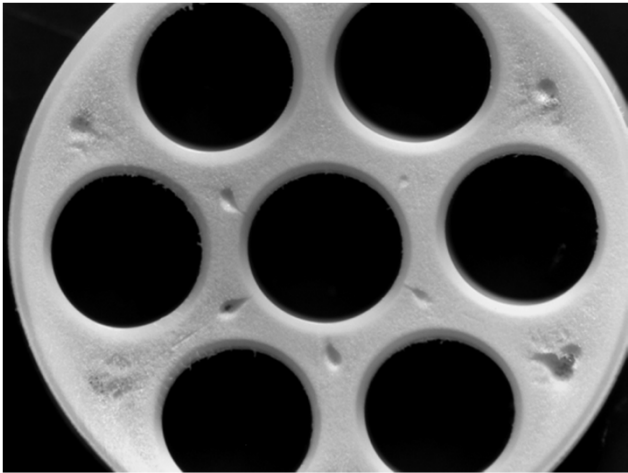

SEM cross-section of SB 27

SB	matrix	additive	PWP [kg/h*m ² *bar]	MWCO [kDa]
27	PPSU	TB: 7.4k PPSU/AT80	972	31
	PESU	Standard	1090	37



Results MABMEM project – membrane surface properties

Testing of dizzer lab modules

Location: Varel
Waste water
4th cleaning step

OOWV
gemeinsam · nachhaltig · transparent

WAG Roetgen
Surface water 6800 m³/h
From July 2018 (KW 28)

enwor
energie & wasser vor ort

Triflux Demonstrator testing equipment

Results MABMEM project – membrane surface properties

Testing of dizzer lab modules: quality of raw water

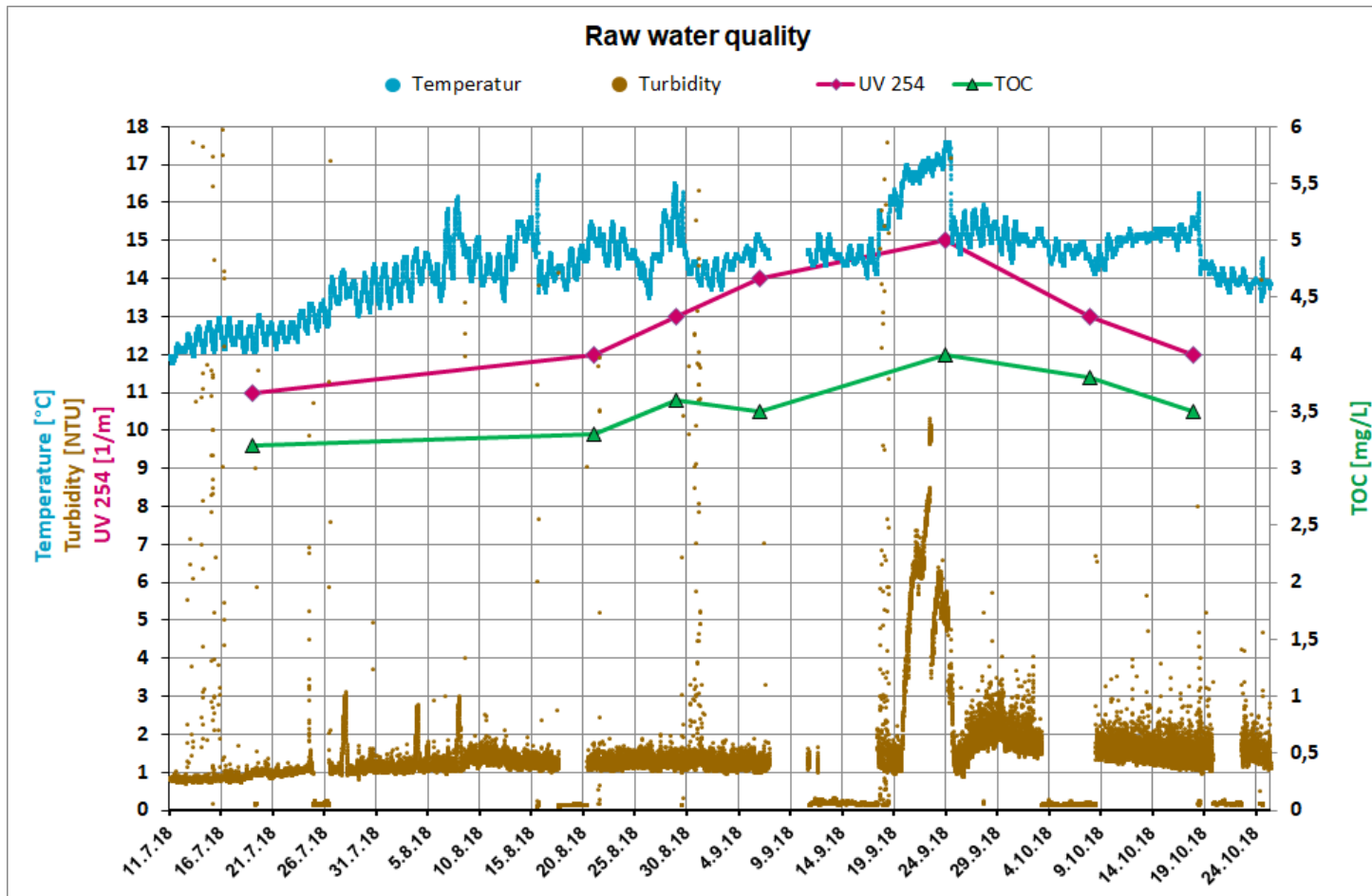

Dreilaegerbach reservoir

- 11.7 – 25.10.2018
- average surface water
- Typical seasonal fluctuations in raw water quality
- demanding for membrane process

Results MABMEM project – membrane surface properties

Testing of dizzer lab modules: process performance

SB 27 - 7,4 kDa PPSU/AT80 in PPSU

● TMP in mbar ● Permeability@ 20°C in l/(m²·h·bar) ● Flux in l/(m²·h)

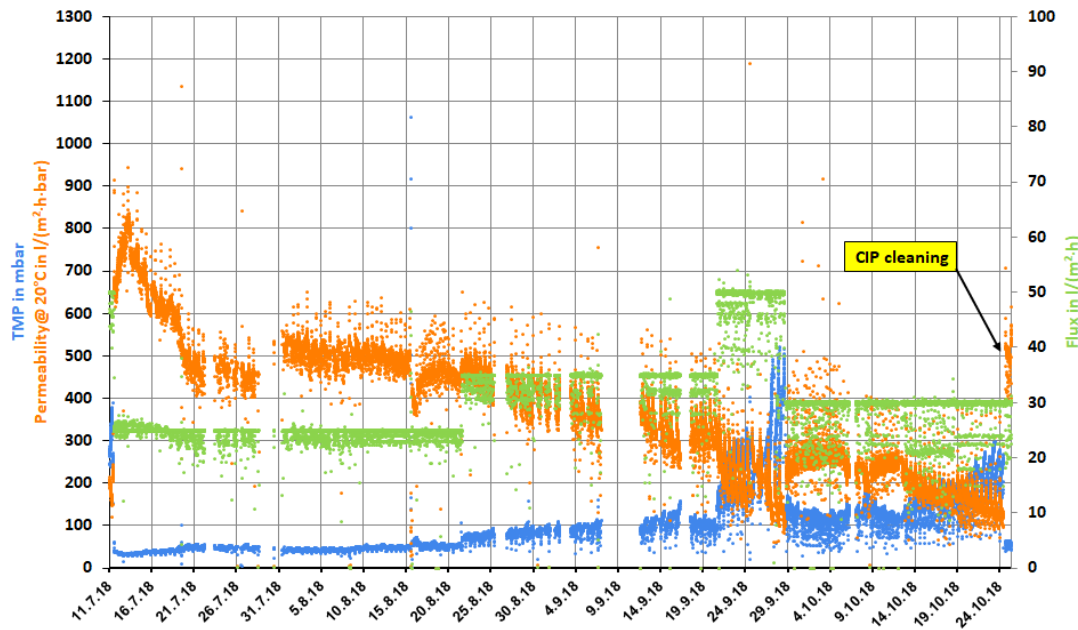

Standard PESU

● TMP in mbar ● Permeability@ 20°C in l/(m²·h·bar) ● Flux in l/(m²·h)

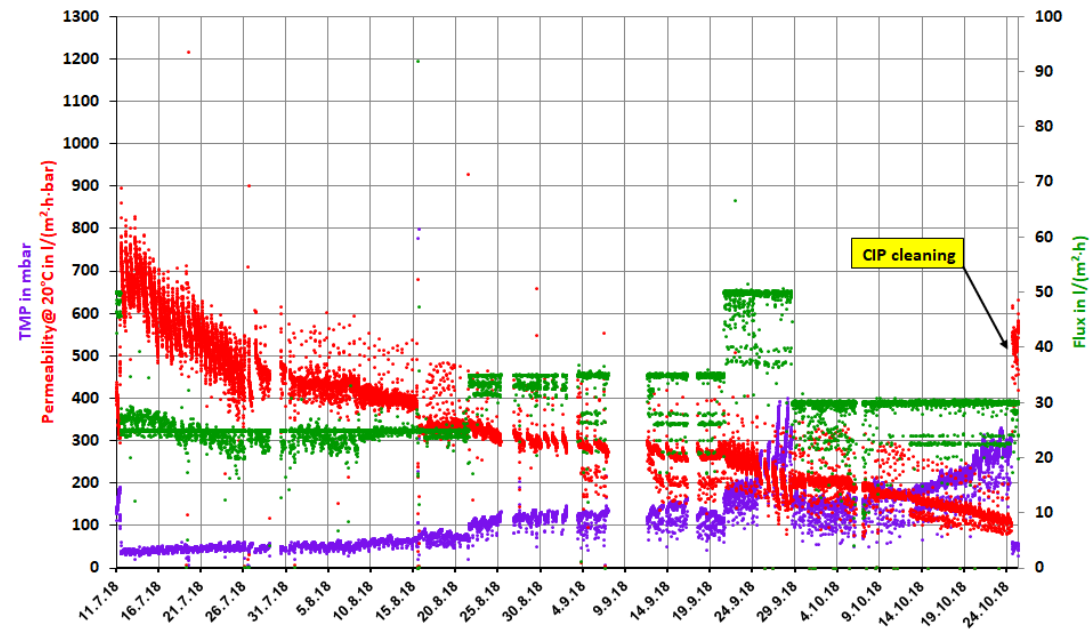

- without upstream flocculation
- flux 25 / 30 / 35 / 50 kg/m²·bar·h
- in average 20 – 25 % higher permeability of SB27 compared to PESU

Results MABMEM project – membrane surface properties

Testing of dizzer lab modules: Cleaning in detail

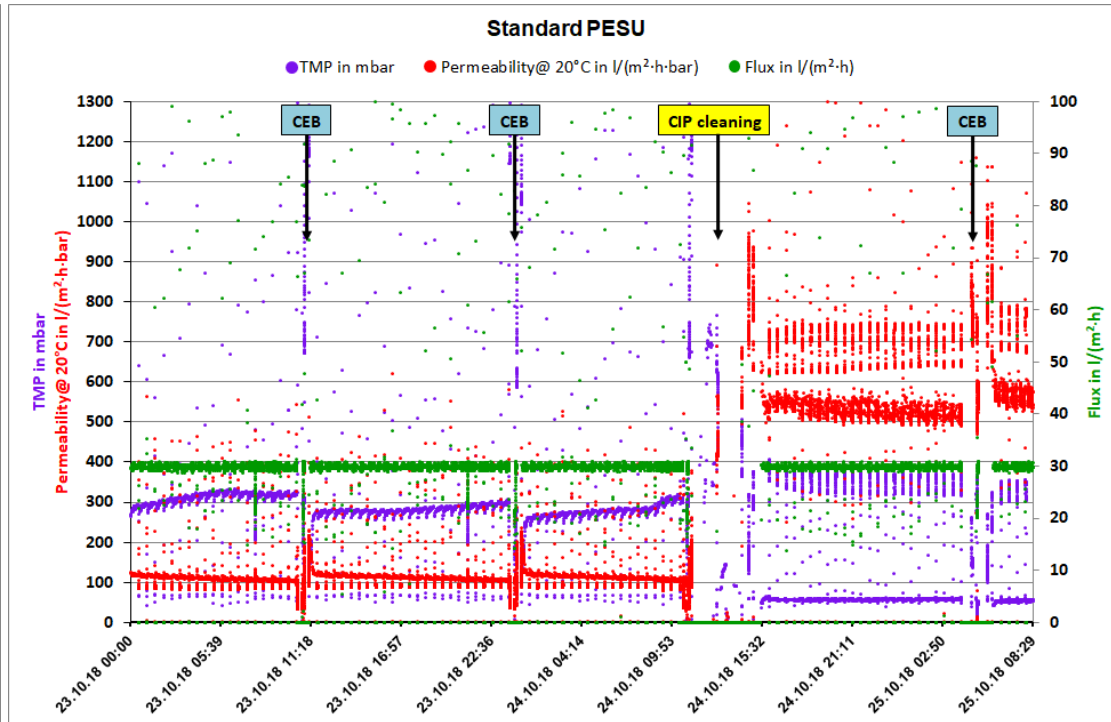
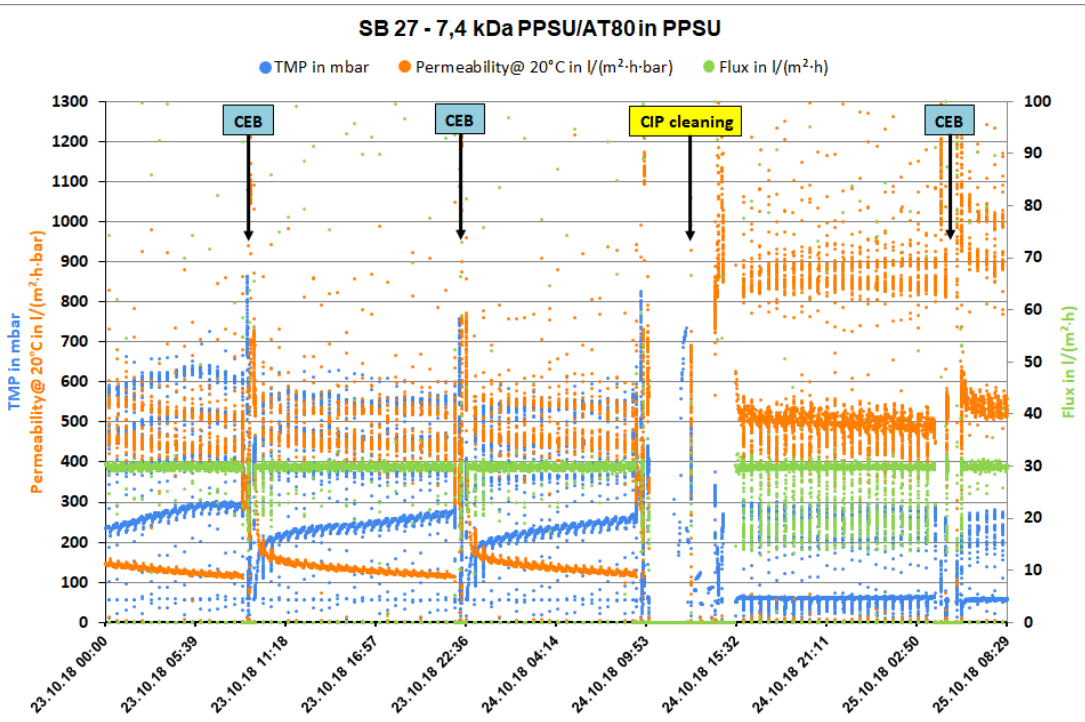

- Cleaning steps in detail
- CEB: NaOH (pH12.3) / H₂SO₄ (pH 2.0) – twice per day
- CIP: 200 ppm NaOCl / NaOH (pH12), 30 min flush forward / 30 min filtration (70 l/h)

Results MABMEM project – membrane surface properties

Testing of dizzer lab modules of PPSU development candidates: summary

	7.4 kDa PPSU / AT80 in PPSU	Standard PESU inge
Experimental period	11.07.18 – 25.10.2018	
Flocculation	None	
Flux [l/m ² /h]	25 / 30 / 35 / 50	
Filtration time [min]	30	
CEB	Combined regime: NaOH (pH12,3) / H ₂ SO ₄ (pH 2,0) – 2x per day	
Average permeability@20 [l/m ² /h/bar]	800 - 140	700 - 110
Deviation of average permeability in reference to standard PESU [%]	+ 20 - 25	-
CIP	NaOCl (200 ppm) + NaOH (pH 12) 30 min Forward Flush / 30 min Filtration (70 l/mh)	

Conclusion

- TB and MB Lutensol AT80 and Pluronic F127 PPSU additives with 8.4 wt% in PPSU FS matrix:
 - ▶ 18 – 62 % permeability increase compared PPSU ultrafiltration membranes
 - ▶ molecular weight cut-off values with 23 – 62 kDa in ultrafiltration range
 - ▶ defect free membrane morphologies in SEM cross-section
 - ▶ contact angle of 55- 60 ° compared to 85 ° (PPSU reference): improved hydrophilicity
- TB and MB Lutensol AT80 and Pluronic F127 PPSU additives in PPSU SB matrix:
 - ▶ additive surface agglomeration indicated by ¹HNMR and XPS
 - ▶ reduced fouling propensity with flower soil extract as testing model
- PPSU MB demonstrator testing with TB 7.4k PPSU- Lutensol AT80 additives Dreilägerbach reservoir
 - ▶ 20- 25 % higher permeability in average compared to PESU standard (without flocculation)

Acknowledgements

- BMBF for funding



- PTJ for support



- MABMEM-Team

UNIVERSITÄT
DUISBURG
ESSEN

Offen im Denken

Mathias Ulbricht
Stefan Panglisch
Inga Stratmann
Arman Kouchaki

••••• Helmholtz-Zentrum
Geesthacht

Centre for Materials and Coastal Research

Volker Abetz
Ulrich Handge
Lara Grünig
Joachim Koll



Martin Heijnen
Michaela Krug

• BASF
The Chemical Company

Martin Weber
Elke Dietz
Karin Schwitzky

IWW

IWW WATER CENTRE

Marcel Koti
Andreas Nahrstedt

• BASF
We create chemistry

 **BASF**

We create chemistry